



SECTION A1
SERIES 200 AND 300 ENTRANCE DOORS

TABLE OF CONTENTS

Features	3
Series 200 Entrance.....	4
Series 300 Entrance.....	5
Miscellaneous Muntins and Bottom Rails	6

THIS PAGE INTENTIONALLY LEFT BLANK

Acro Aluminum door styles:

- **Series 200 Narrow Stile**
- **Series 300 Medium Stile**

All aluminum entrance doors feature mechanically connected corner construction allowing for excellent structural strength and integrity. These mechanically fastened corners remain rigid and square without sagging. All doors are backed by a **Lifetime Limited Warranty**.

Available in a wide range of finishes including clear and bronze anodized and a multitude of custom painted colors.

Doors Available in single & double glazed

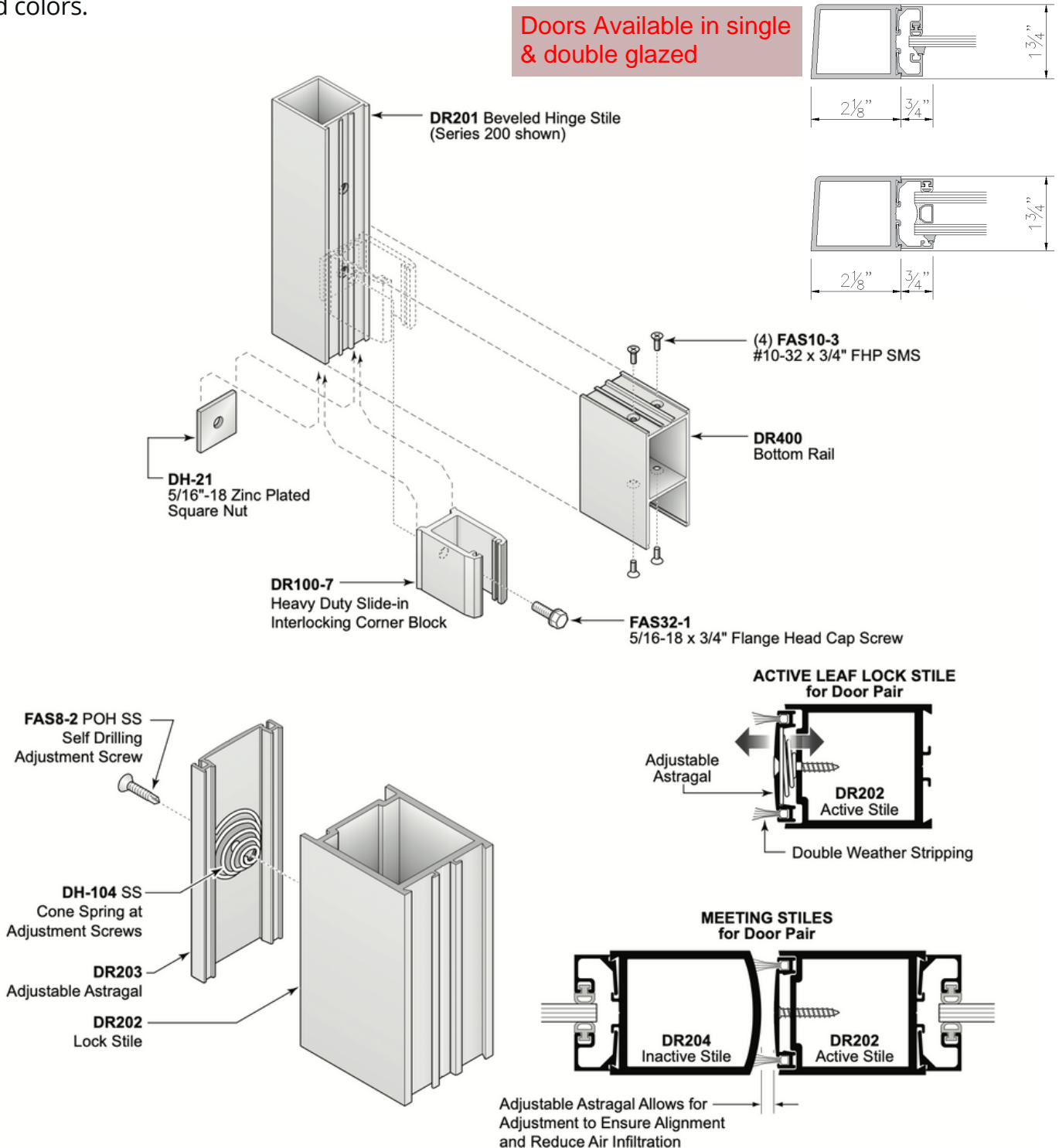

SERIES 200 NARROW STILE

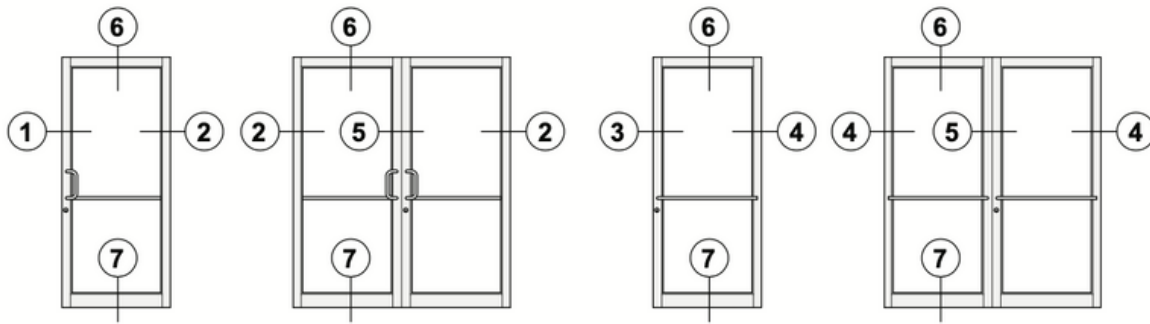

OFFSET HUNG DOORS

CENTER HUNG DOORS

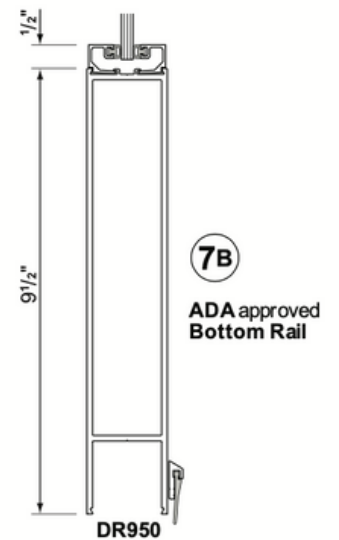
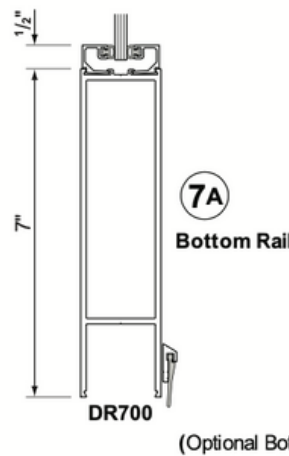
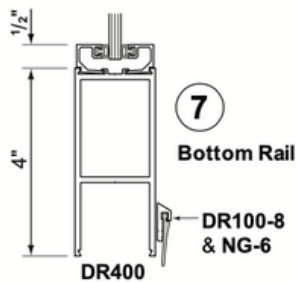
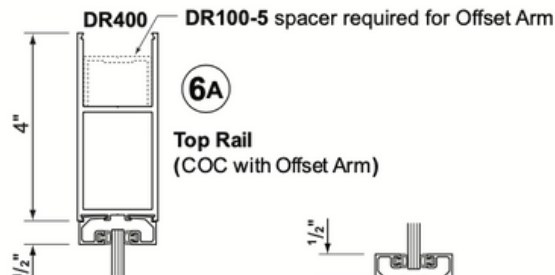
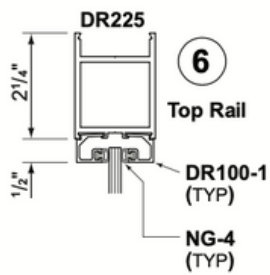
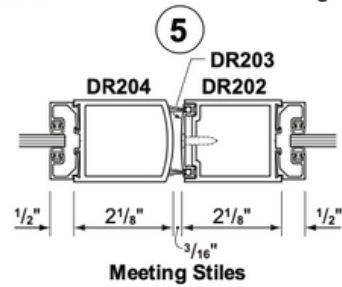
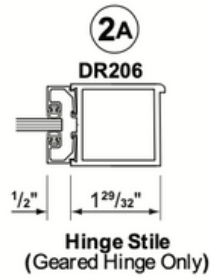
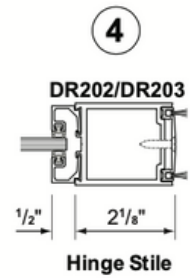
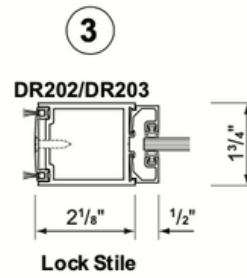
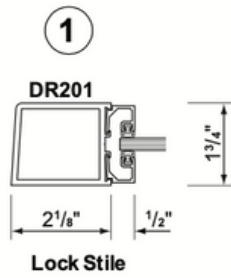

SERIES 300 MEDIUM STILE



OFFSET HUNG DOORS

CENTER HUNG DOORS

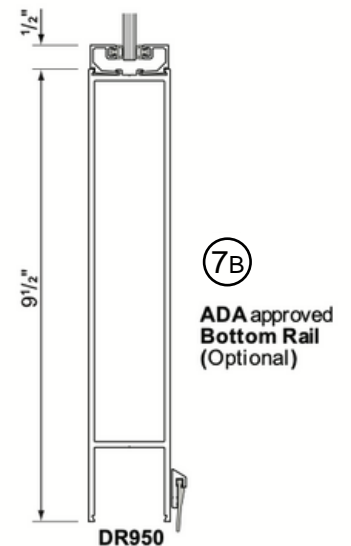
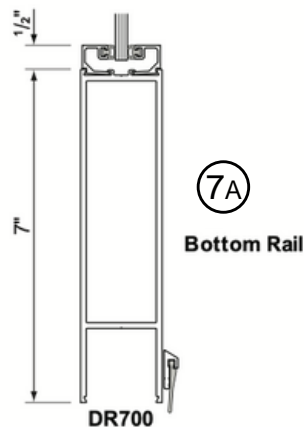
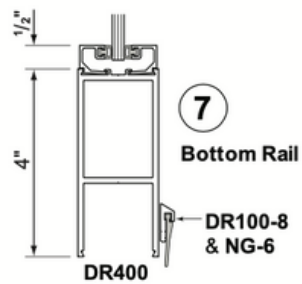
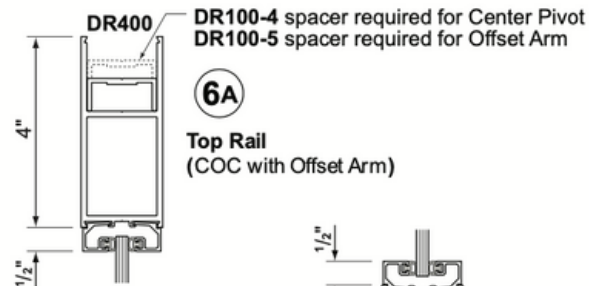
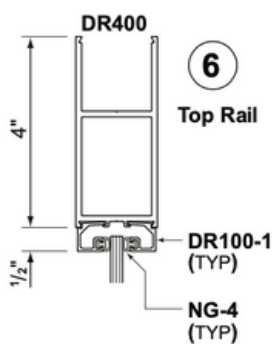
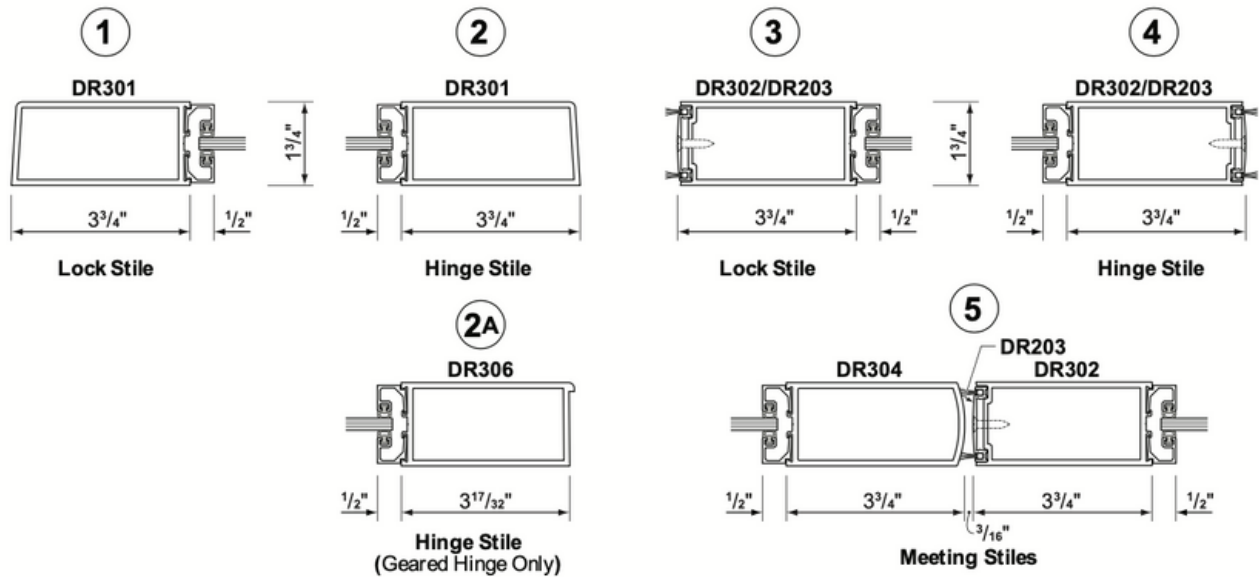

MISCELLANEOUS MUNTIN AND BOTTOM RAILS

Muntin

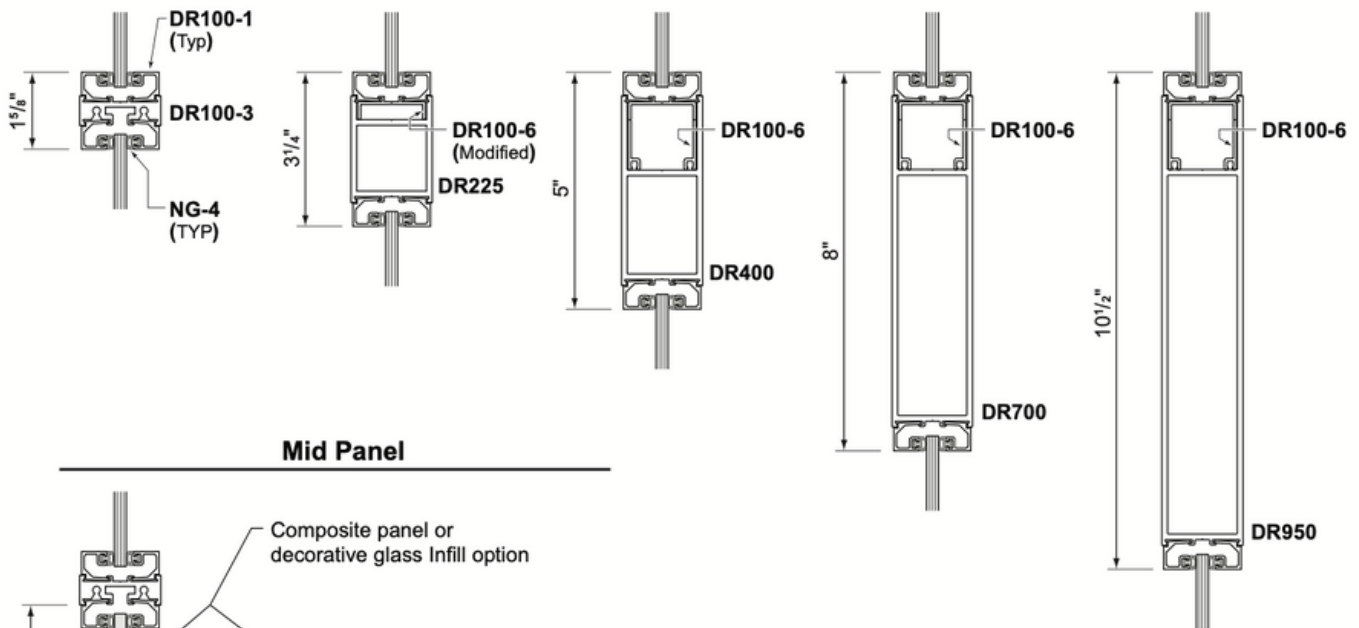

Mid Panel

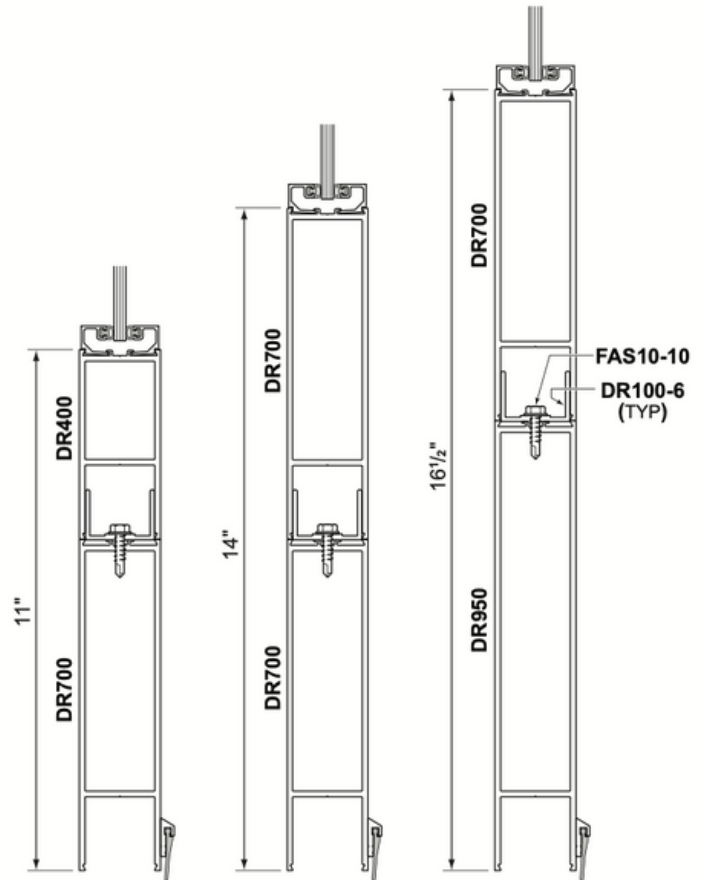
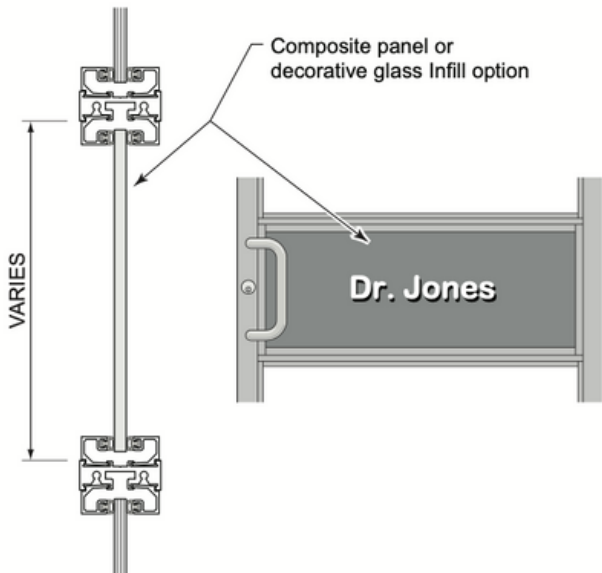

Bottom Rails

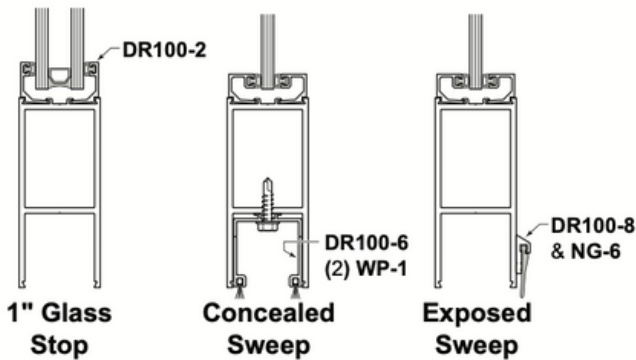

Stacked Bottom Rails
Not recommended for showroom or bi-fold doors